

Typical Performance Technical Data Sheet



Catalog No. T20LB42-45

Characteristics	
Phase	3
KVA	45
Primary	208Δ
Secondary	480Y/277
Conductor	Aluminum
Temp. Rise	80° C
Frequency	60 HZ
Taps	+2, -2 x 2.5%
ESS	No
Insulation	220° C
Weathershield	WS-18
Wall Bracket	WMB-4
Weight (lbs)	685
Sound (dB)	45

Typical Performance @ 100° C	
Regulation @ 100% PF	1.4%
Regulation @ 80% PF	2.6%
Impedance	2.9%
No Load Losses (W)	143
Full Load Losses (W)	618

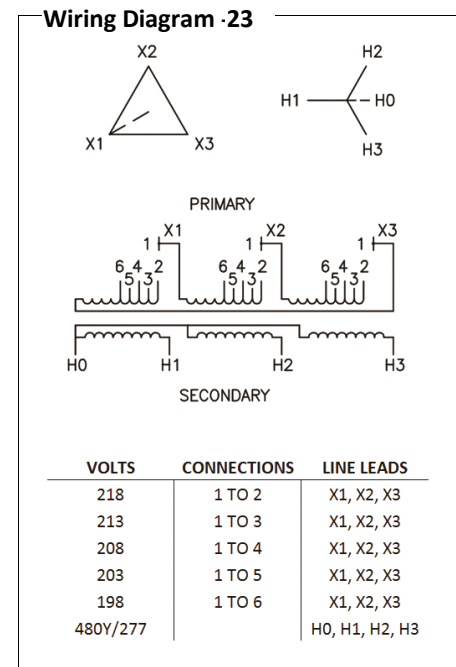

AMP Ratings	
Line In (Primary) @ 208V	125 A
Load (Secondary) @ 480V	54 A

Notes

All units are UL listed and are designed in accordance with applicable NEMA, ANSI and IEEE standards. Transformers are dry-type AA, ventilated NEMA 2 enclosure. If a weathershield is indicated above this transformer can be converted to a NEMA 3R enclosure. Transformers are floor mounted. Wall mounting bracket kit if shown above is optional and is supplied as a separate accessory. Paint color is ANSI 61.

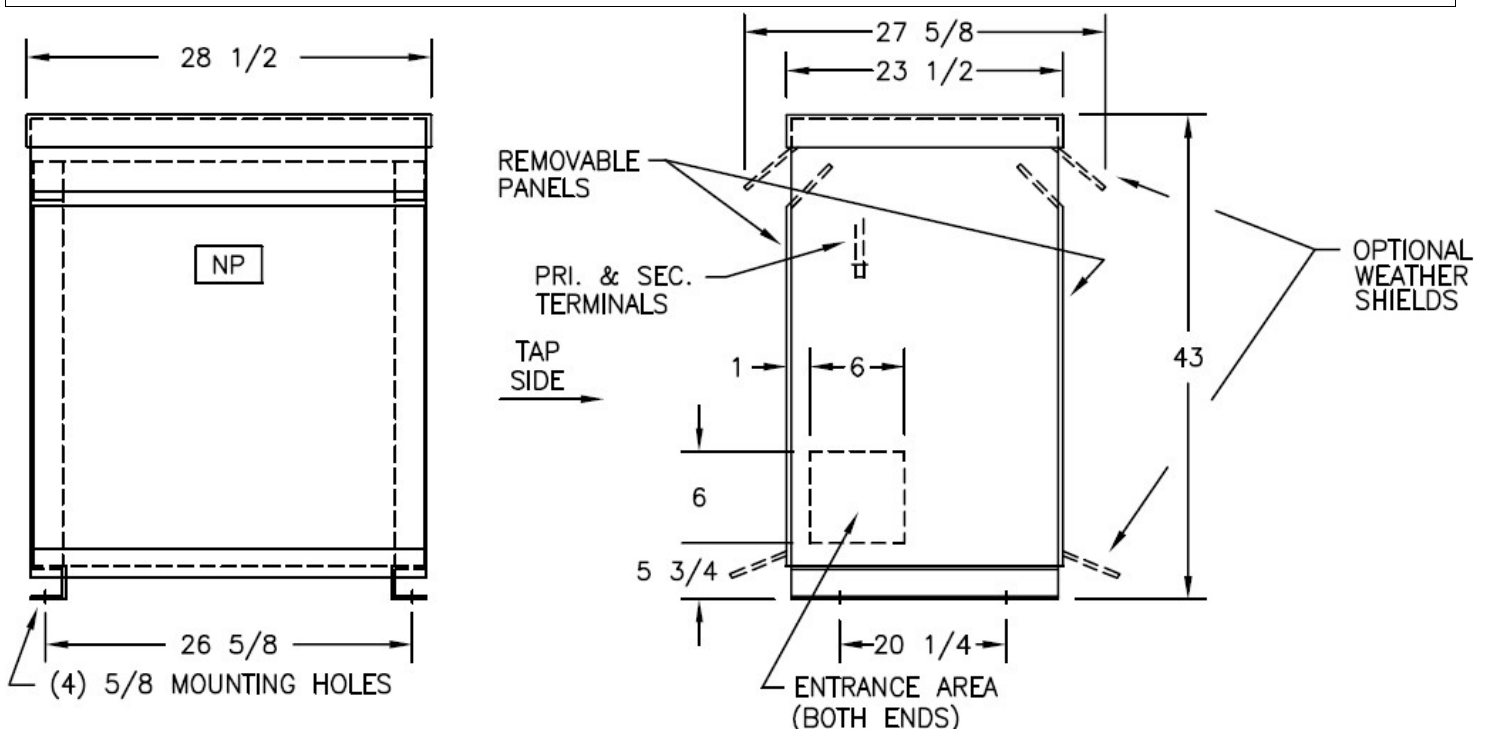

Outline No: 08A3305

Meets 10 CFR 431(DOE 2016) Efficiency
Dry Type Transformer General Purpose

© 2017 Electro-Mechanical Corporation

For reference only
Subject to change without notice